



Art.-Nr: ILDL423WL-3P
Safety luminaire Single Battery
CS_VALUE_MountingMethod.Schienensysteme, Wireless Professional (WL), 3 h, , IP40, Plastic, white



The simple plastic safety luminaire for fitting on the ceiling is a real all-rounder. The luminaire is equipped for virtually all requirements and always provides the right solution. The IL surface-mounted luminaire comprises just 2 parts; the ceiling section contains the mains supply terminals.

The pre-mounted 3-phase adapter allows for tool-free installation in popular 3-phase tracks, such as Nordic Aluminium GLOBAL pro (previously NOKIA) XTS, XTTS and XTSC.

Wireless central control and monitoring for large installations of up to 50,000 luminaires with Wireless Professional. The innovative integrated lens holder with a rapid fitting fixture permits the flexible use of various lens types. Using the right lens allows the distribution of light to be matched perfectly to the application and simplifies illumination which satisfies all relevant standards. A round lens and hall lens are supplied with every luminaire, allowing it to be adapted perfectly to the respective mounting situation. Other lenses, such as a spotlight lens, beam lens or H lens, are available as options.



More information

www.rp-group.com/en/item/ILDL423WL-3P



TECHNICAL DATA

Luminaire type	Safety luminaire
Mounting	CS_VALUE_MountingMethod.Schienensysteme
Pictograph	No
Illuminant	LED
Housing material	Plastic
Housing color	white
Protection type (IP)	IP40
Impact resistance (IK)	≥ 3
Certification	WEEE, CE, TÜV Rheinland Type approved, ENEC
Insulation class	2
Supply	Single Battery
Monitoring	Wireless Professional (WL)
Bridging time	3 h



Battery	LiFePO4 3,2V V/3,3 Ah
Operating mode	Standby circuit / permanent circuit
Input voltageAC	230 V
Input frequency	50 / 60 Hz
Power max.	3,4 W
Power DS	2,3 W
Power BS	0,4 W
Ambient temperature DS	-5 °C - 40 °C
Ambient temperature BS	-5 °C - 40 °C
Height	36 mm
Diameter	100 mm
Weight	0.19
Weight incl. packaging	0.25
Connection cross-section	2.5 mm ²
Switching input	Yes
Emergency light blocking	No
Battery connection	Connector
Dimming function	Yes
Luminous flux mains	130 lm
Luminous flux emergency	250 lm
Customs tariff number	94056120
EAN	4260682155597



TECHNICAL DRAWING

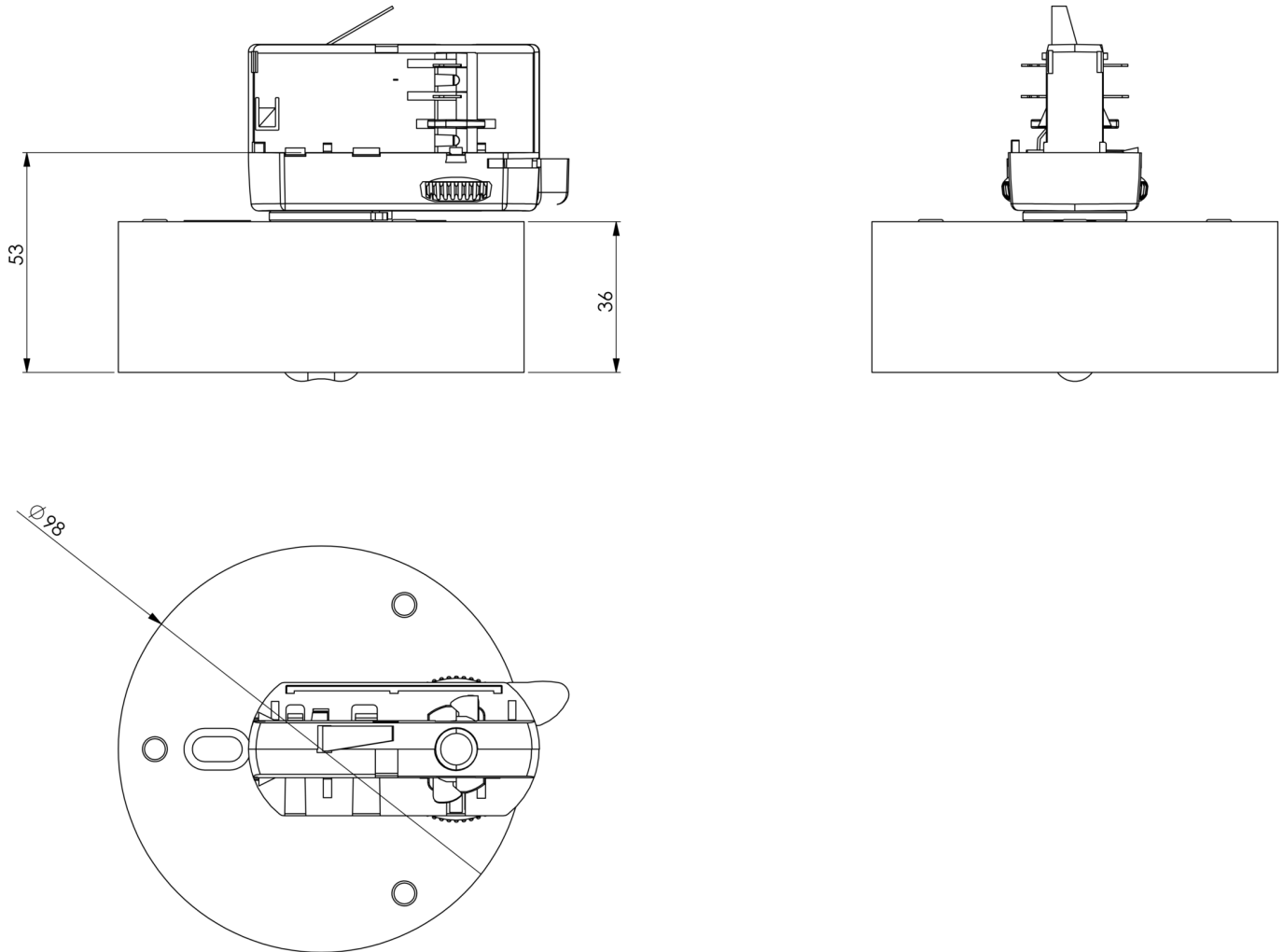





ACCESSORY LIST

- LSYS-B4 -
- LSYS-F4 -
- LSYS-H4 -
- LSYS-R4 -
- LSYS-S4 -

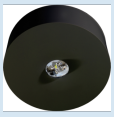
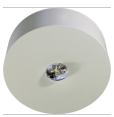
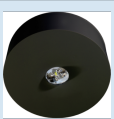

RELATED PRODUCTS

Art.-No.	Image	Monitoring	Supply	Color	Investment	Automatic log	Maintenance level	Remote maintenance	max. luminaires	Single luminaire monitoring
ILD423SC		SelfControl (SC)	Single battery	RAL 9003	€	no	high	no	unlimited	itself
ILD423SC-SW		SelfControl (SC)	Single battery	RAL 9005	€	no	high	no	unlimited	itself
ILD423WL		Wireless Professional (WL)	Single battery	RAL 9003	€€	yes	low	yes	1,000 per system	central
ILD423WL-SW		Wireless Professional (WL)	Single battery	RAL 9005	€€	yes	low	yes	1,000 per system	central
ILD423SC-3P		SelfControl (SC)	Single battery	RAL 9003	€	no	high	no	unlimited	itself
ILD423SC-SW-3P		SelfControl (SC)	Single battery	RAL 9005	€	no	high	no	unlimited	itself
ILD423WL-SW-3P		Wireless Professional (WL)	Single battery	RAL 9005	€€	yes	low	yes	1,000 per system	central

As of: 11.10.2024 - Subject to technical changes and errors.